



Protecting properties  
since 1985



**SeceuroDoor**  
Industrial Doors

**35 YEARS**  
1985-2020  
ANNIVERSARY

Jan 2022



# Welcome to the SeceuroDoor range of steel Commercial &

SWS UK products have been protecting properties since 1985.

Our steel commercial and industrial doors are a robust alternative to our aluminium range of security products and still offer versatility through the ultimate choice our complete range offers. Encompassed within the range are single skin industrial doors and insulated industrial doors. In addition, we offer hand chain operated industrial doors, steel insulated doors with tubular motors and a wide choice of industrial door motors including GfA. Choose your product, then simply pick your preferred motor. A wide choice of colours and finishes are available and by the use of different gauge slats we are able to accommodate even larger sizes than ever before.

## All SeceuroDoor products are:

- ✓ CE or UKCA marked – Investing in a CE or UKCA marked product means you are purchasing a product that is fully compliant
- ✓ Approved LPCB products available
- ✓ SWS UK is an ISO9001 and ISO14001 Certified Company
- ✓ Manufactured in the UK
- ✓ Made to measure for a tailor made solution

## Reason to choose SeceuroDoor

### Features and Benefits

- Choice of motors
- Universal, laser-cut, folded endplate (giving greater strength)
- Angles pre slotted for inset & outset
- Deburred door edges for easier (and safer) fitting
- Predrilled guide channels with low profile bolts
- Welded tabs as standard to correct coning issues & prevent slat jump if the limits are lost
- Axle predrilled & RivNuts, instead of welded nuts or studs, for ease of installation
- Slotted top slat instead of attachment strips for greater flexibility on site
- 350 mm box & endplate for lower headroom requirements which also brings the axle better in line with the guides on smaller doors
- Online configurator automatically suggests drive options based on expected usage

## GfA Extended Warranty

Only SWS UK offers an extended 2-year warranty on GfA industrial motors, when you register each drive using the GfA bluetooth dongle. Registration is easy and comes with a host of other benefits:

- View and track all your registered GfA assets in one place
- Monitor ongoing usage
- Keep track of drive settings over time
- Access a comprehensive library of fault codes
- Synch your service records

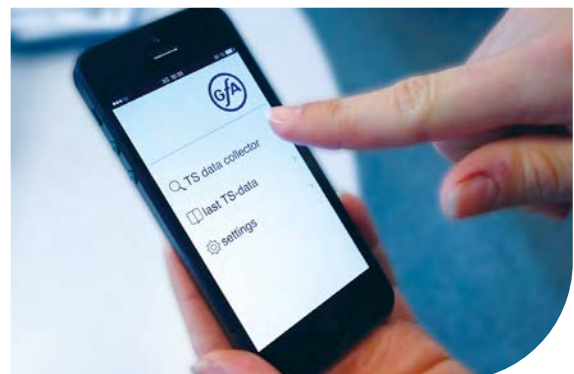

# SeceuroDoor Product Matrix

		Slats		Motors													
		Overall Maximum Sizes (mm)	Single Skin Slat	Insulated Slat	Tube Motor	Inboard Motor	Direct Drive Motor	Manual Option	Insurance Approved	Heat Transmission of Lath W/m²K	Wicket Door	Vision	Standard Colour	RAL Option	Plastisol Option	Safety Edge	
Tubular	SeceuroDoor 75 Continental	5800 x 3400	●		●			●		N/A		●	White, Black, Brown, Cream, Galvanised	●	●	●	
	SeceuroDoor 75 Traditional	7000 x 5000	●		●			●		N/A	●	●	White, Black, Brown, Cream, Galvanised	●	●	●	
	SeceuroDoor 7501	6000 x 4800	●		●			●	●	N/A		● (Perf only)	White, Black, Brown, Cream, Galvanised	●	●		
	SeceuroDoor 77t	6000 x 3400		●	●					4.01			Galvanised	●		●	
		Clear Opening Maximum Sizes (mm)	Single Skin Slat	Insulated Slat	Tube Motor	Inboard Motor	Direct Drive Motor	Manual Option	Insurance Approved	Heat Transmission of Lath W/m²K	Wicket Door	Vision	Standard Colour	RAL Option	Plastisol Option	Safety Edge	
Industrial	SeceuroDoor 75 Single Skin	7000 x 7000	●			●	●			N/A	●	●	Galvanised	●	●	●	
	SeceuroDoor 7502	6200 x 4600	●			●	●		●	N/A			Galvanised	●	●		
	SeceuroDoor 77 Insulated	20 m² (Max width 6 m)		●		●	●			4.01			Galvanised	●		●	
	SeceuroDoor 95 Insulated	44 m²		●		●	●			Centre: 1.1 Quirk: 3.2		●	Galvanised	●	●	●	
	SeceuroDoor 9501 Insulated	44 m²		●		●	●		●	Centre: 1.1 Quirk: 3.2			Galvanised	●	●	●	
	SeceuroDoor 100 Insulated	7000 x 7000		●		●	●			Infill piece: 0.553		●	Galvanised	●		●	
Manual	SeceuroDoor 75c Chain Op	5000 x 5000	●					●		N/A	●	●	White, Black, Brown, Cream, Galvanised	●	●		
	SeceuroDoor 77c Chain Op	5000 x 4000		●				●		4.01			Galvanised	●			

## Galvanised Steel Single Skin Continental Commercial Shutter

- This is our original commercial shutter
- White, Brown, Black and Cream as standard
- Available in electric or manual operation
- Available in 18g (POA), 20g and 22g
- Strong single skin galvanised steel profile
- Can be powder coated any RAL / BS colour
- Will reverse coil if required (will increase coil size)
- Plastisol colours available
- Manual Spring & Lock – When there is no power available for electric operation or the shutter will not be opened very often. The solution is not available for shutters over 2.8 m tall.
- Max width up to 5800 mm
- Max height up to 3400 mm
- Max area up to 20 m<sup>2</sup>
- Wind class rating: Class 2 (when used on 65 mm+ guides)

### Vision option available

- Delivers up to 25% vision (when back lit)
- Can be mixed with solid SeceuroShield 75 when only partial vision is required

## Galvanised Steel Single Skin Traditional Commercial Shutter

- Strong single skin galvanised steel profile
- White, Brown, Black and Cream as standard
- Available in 18g (POA), 20g and 22g
- Medium security office / commercial / industrial applications
- Spans widths up to 7000 mm
- Can be powder coated any RAL / BS colour
- Will reverse coil if required (will increase coil size)
- Plastisol colours available
- Manual Spring & Lock – When there is no power available for electric operation or the shutter will not be opened very often. The solution is not available for shutters over 2.8 m tall.
- Max width up to 7000 mm
- Max height up to 5000 mm
- Max area up to 35 m<sup>2</sup>
- Wind class rating: Class 2 (when used on 65 mm+ guides)

### Vision option available

- Delivers up to 25% vision (when back lit)
- Can be mixed with solid SeceuroShield 75 when only partial vision is required

### BOTTOM RAILS AND GUIDE OPTIONS

#### TRADITIONAL ONLY

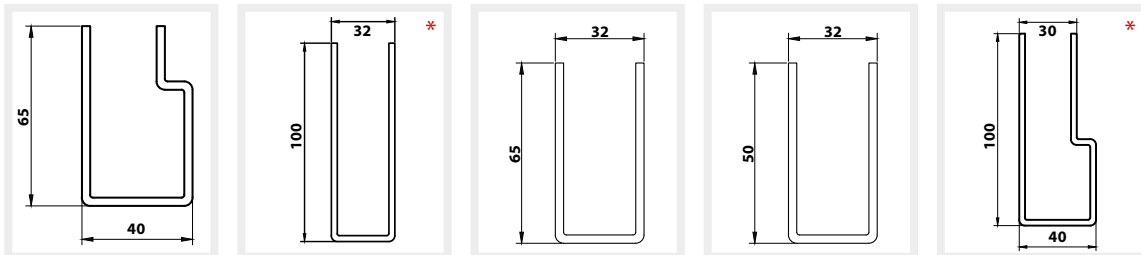

\* Optional extra

#### BOTH TRADITIONAL AND CONTINENTAL

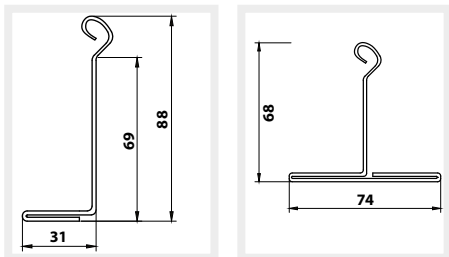

#### CONTINENTAL ONLY

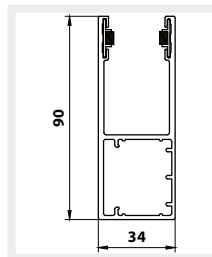

#### STOCK COLOURS FOR CURTAIN (SLATS), BOTTOM SLAT, BOX & GUIDES



#### BOX & GUIDES

Boxes and guides are supplied in White, Brilliant White, Black, Brown, or Cream at no extra charge.

#### Please note:

Colour references on standard product are a guide only and will not match powder coated finish.

#### SLAT (SOLID)

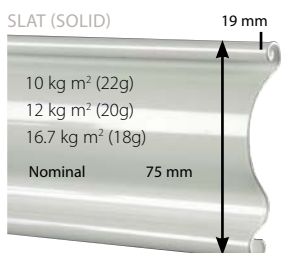

#### SLAT (PERFORATED)

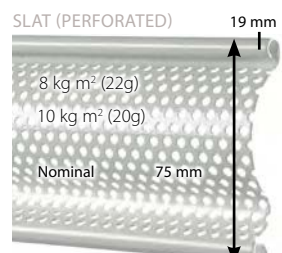

#### VISION SLAT (PUNCHED)\*

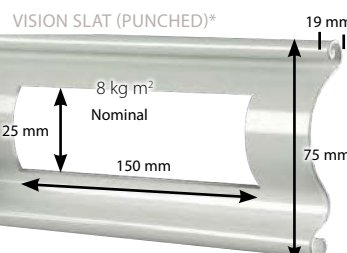

#### Punched Curtain

150 mm x 25 mm regular punched hole with 50 mm space between. Available as brick bond or in line configuration. Provides 25% vision. Not available in a galvanised finish, must be powder coated. Price does not include powder coating. (Priced on clear opening sizes).

\*Please note: Punched products must be powder coated

## Insurance approved security shutters tested to Loss Prevention Standard 1175 (LPS1175)

The rigorous LPS 1175 burglary resistance standard is operated by the Loss Prevention Certification Board (LPCB). LPCB are the UK's leading independent certification body and the LPS 1175 standard is recognised and endorsed by 16 organisations including the Association of British Insurers and the Association of Police Officers.

- Traditional and Continental design
- White, Brown, Black and Cream as standard
- Available as solid or perforated
- Strong single skin galvanised steel profile
- Medium security office / commercial / industrial applications
- Spans widths up to 6000 mm
- Can be powder coated any RAL / BS colour
- Flexibility to mix solid and perforated slats together when only partial vision is required
- Will reverse coil if required (will increase coil size)
- Available with either traditional or continental specifications
- Only available in 22g slat
- Wind class rating: Class 2 (when used on 65 mm+ guides)

### BOTTOM RAILS AND GUIDE OPTIONS

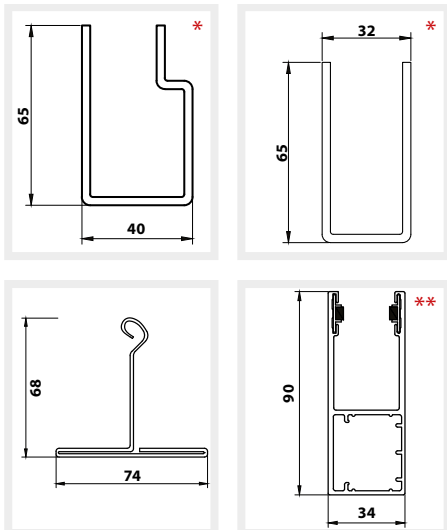

\* Traditional only    \*\* Continental only

### STOCK COLOURS FOR CURTAIN (SLATS), BOTTOM SLAT, BOX & GUIDES



**BOX & GUIDES**  
Boxes and guides are supplied in White, Brilliant White, Black, Brown, or Cream at no extra charge.

**Please note:**  
Colour references on standard product are a guide only and will not match powder coated finish.

### Traditional Design

Traditional shutter construction employing steel channel and angle guides with electric or manual operation.

- ✓ Stronger construction, more suitable for larger sizes
- ✓ Endplate attached to angle therefore more suitable for shutters where the headplate requires additional support

### Continental Design

A shutter with a neat continental style head box and aluminium guides for higher grade installations. The design facilitates easier installation than traditional shutters.

- ✓ Aluminium guide width 90 mm
- ✓ Neat design

### BOX EXTENSION

A box extension is required on built-on SeceuroShield 75 shutters when the curtain weight exceeds 172 kg on a 4" axle and 134 kg on a 5" axle. The projection is just 30 mm for face fixed shutters. If the shutter is reveal fixed the gap is made up using a 30 mm packer, as shown in the illustration. The overall width used when pricing and ordering shutters with box extensions is the overguide width (not including the box extension or 30 mm packer). If you are in any doubt please contact our technical team.

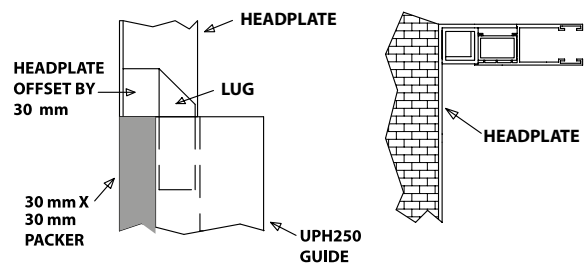

**THIS PRODUCT CAN BE POWDER COATED**  
Please note: that this product will be powder coated after it has been assembled.

**THIS PRODUCT CAN BE PLASTISOL COATED**  
Please note: this finish applies to the external face of the curtain slat only.



## Galvanised insulated commercial shutter

Our Insulated Commercial Shutter combines all the qualities of our robust SeceuroDoor 75 but with the added benefit of insulation.

### Thermal and Acoustic Insulation

Minimal thermal bridges and the use of fine-pored PU rigid foam infill ensure good thermal insulation whilst curtain and sealing technology used around the entire shutter reduce noise from both inside and outside.

- Heat transmission performance for the 77 mm single slat profile 4.01 W/(m<sup>2</sup> K)
- Max width up to 6000 mm
- Max height up to 3400 mm
- Max area 20 m<sup>2</sup>
- Can be powder coated any colour, see [Page 15](#)
- Standard guide angle is 75 mm x 50 mm  
Other sizes are available on request

#### SLAT, BOTTOM SLAT AND GUIDE

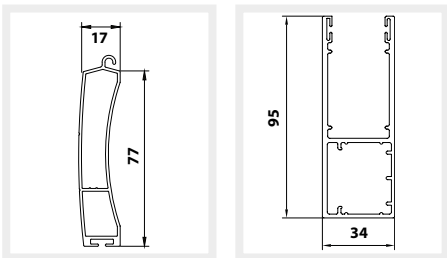

#### SLAT (INSULATED)



#### STANDARD CURTAIN & BOTTOM SLAT FINISH: GALVANISED



**THIS PRODUCT CAN BE  
POWDER COATED**

**Please note:** that this product will be powder coated after it has been assembled.

### Easy Online Ordering

Our intuitive online system lets you order with ease. With SWS Online you can raise instant quotations 24-hours a day, access bespoke technical drawings, view and manage your orders or request a callback, all at the click of a button.



### SeceuroPart Spare Parts & Components

Need a replacement part or component quickly? Use SeceuroPart for next day delivery on 100s of stock items. Browse or search the online catalogue, with useful tools to help you find the right replacements and spares. Order replacement slats based on the size of the door or use our intelligent motor selection tool to help you choose the right motor. You can also order bespoke packers, angles and box sections in our easy online configurator.

## Galvanised steel single skin industrial door

- Steel roller shutter with scrolled slat profile. A popular choice for medium security retail and industrial applications.
- Strong single skin galvanised steel profile
- Can be powder coated any RAL / BS colour
- Your choice of motor, see **Page 13**
- Available with 18g (POA), 20g or 22g steel slat
- Choice of 4 guide arrangement options
- Standard guide angle is 75 mm x 50 mm. Other sizes are available on request
- Maximum width 7000 mm
- Maximum height 7000 mm
- Maximum area 49 m<sup>2</sup>

## Galvanised steel single skin industrial door with vision

All the benefits of the SeceuroDoor 75 but with the addition of vision.

- Strong single skin galvanised steel profile
- Delivers up to 25% vision when back lit
- Suitable for commercial, industrial and retail applications
- Provides an attractive alternative to the traditional steel shutter
- Can be powder coated any RAL / BS Colour
- Your choice of motor, see **Page 13**
- Available with 18g (POA), 20g or 22g steel slat
- Choice of 4 guide arrangement options
- Standard guide angle is 75 mm x 50 mm. Other sizes are available on request
- Can be used in conjunction with SeceuroDoor 75 to give partial vision
- Maximum width 7000 mm
- Maximum height 7000 mm
- Maximum area 49 m<sup>2</sup>
- Max area of vision 16 m<sup>2</sup>
- Wind class rating: Class 2 (when used on 65 mm+ guides)

### BOTTOM RAILS AND GUIDE OPTIONS FOR BOTH PRODUCTS ABOVE

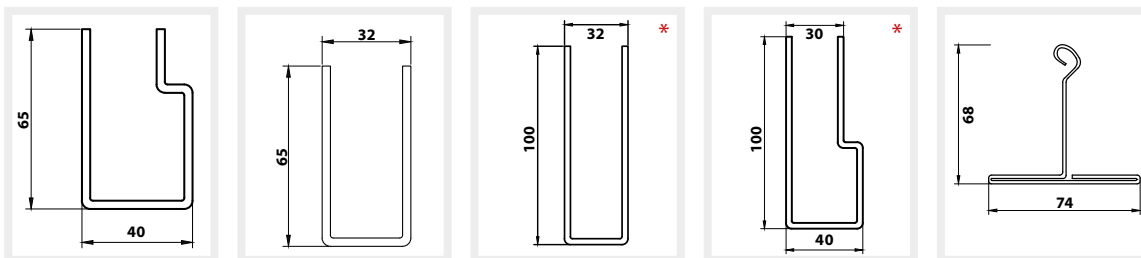

\* Optional extra

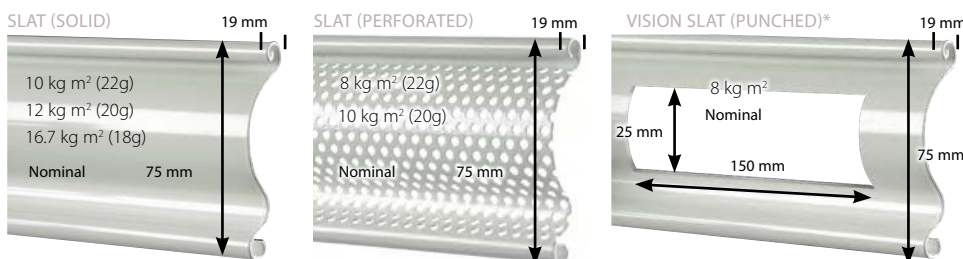

### Punched Curtain

150 mm x 25 mm regular punched hole with 50 mm space between. Available as brick bond or in line configuration. Provides 25% vision. Not available in a galvanised finish, must be powder coated. Price does not include powder coating. (Priced on clear opening sizes).

\*Please note: Punched products must be powder coated



**THIS PRODUCT CAN BE POWDER COATED**

Please note: that this product will be powder coated after it has been assembled.



**THIS PRODUCT CAN BE PLASTISOL COATED**

Please note: this finish applies to the external face of the curtain slat only.

### MOTOR OPTIONS

Comes with a GfA motor as standard. See **Page 13** for further options.



## Insurance approved security shutters tested to Loss Prevention Standard LPS1175 (LPS1175)

The rigorous LPS 1175 burglary resistance standard is operated by the Loss Prevention Certification Board (LPCB). LPCB are the UK's leading independent certification body and the LPS 1175 standard is recognised and endorsed by 16 organisations including the Association of British Insurers and the Association of Police Officers.

- Security level 2
- Galvanised as standard
- Strong single skin galvanised steel profile
- High security industrial applications
- Spans widths up to 7000 mm
- Can be powder coated any RAL / BS colour
- 18g steel slat
- Internal face fit only
- Bullet lock fitted to the internal side as standard (accessed from the inside of the building only)

### BOTTOM RAILS AND GUIDE OPTIONS

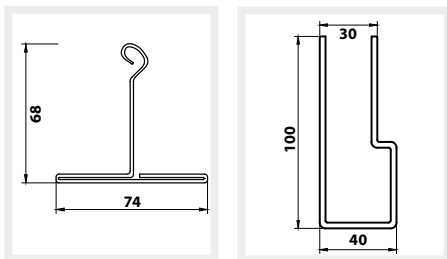

### STANDARD CURTAIN & BOTTOM SLAT FINISH: GALVANISED



**THIS PRODUCT CAN BE POWDER COATED**

Please note: that this product will be powder coated after it has been assembled.



**THIS PRODUCT CAN BE PLASTISOL COATED**

Please note: this finish applies to the external face of the curtain slat only.



## Insulated industrial door

Our Insulated Commercial Shutter combines all the qualities of our robust SeceuroDoor 75 but with the added benefit of insulation.

### Thermal and Acoustic Insulation

Minimal thermal bridges and the use of fine-pored PU rigid foam infill ensure good thermal insulation whilst curtain and sealing technology used around the entire shutter reduce noise from both inside and outside.

- Heat transmission performance for the 77 mm single slat profile 4.01 W/(m² K)
- Max width 6000 mm
- Max area 20 m²
- Your choice of motor, see **Page 13**
- Can be powder coated any colour, see **Page 15**
- Choice of 4 guide arrangement options
- Standard guide angle is 75 mm x 50 mm  
Other sizes are available on request

The entire SeceuroDoor range is available as either a direct drive, inboard, single phase or 3 phase.

### SLAT, BOTTOM SLAT AND GUIDE

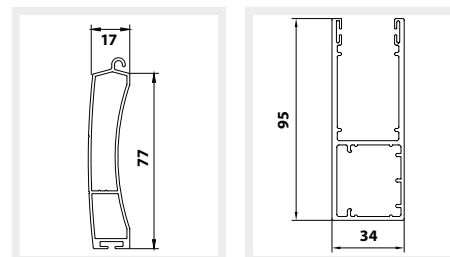

### STANDARD CURTAIN & BOTTOM SLAT FINISH: GALVANISED



**THIS PRODUCT CAN BE POWDER COATED**

Please note: that this product will be powder coated after it has been assembled.

### MOTOR OPTIONS

Comes with a GfA motor as standard. See **Page 13** for further options.



## Insulated industrial door

This insulated steel profile is especially resistant to damage and reduces deflection. With the option of interior and exterior identical colour coating our insulated shutter can easily be blended into the look of any building yet is also available with a galvanised finish.

### Thermal and Acoustic Insulation

Minimal thermal bridges and the use of fine-pored PU rigid foam infill ensure good thermal insulation whilst curtain and sealing technology used around the entire shutter reduce noise from both inside and outside.

- Heat transmission performance for the 95 mm insulated Lath: Centre = 1.1 W/m<sup>2</sup>K, Quirk = 3.2 W/m<sup>2</sup>K
- Max width up to 7000 mm
- Max height up to 7000 mm
- Max area 44 m<sup>2</sup>
- Your choice of motor, see **Page 13**
- Choice of 4 guide arrangement options
- Standard guide angle is 100 mm x 50 mm
- Vision option available: 160 mm x 58 mm Clear Perspex
- Vision Panel with a minimum of 170 mm space in between
- Wind class rating: Class 5

#### SLAT, BOTTOM SLAT AND GUIDES

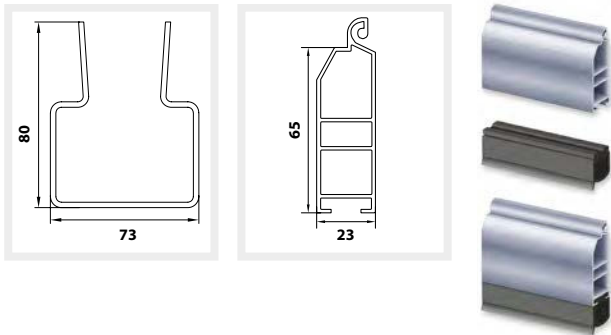

#### SLAT (INSULATED)

13.15 kg m<sup>2</sup>  
Nominal



#### SLAT (VISION)

13.15 kg m<sup>2</sup>  
Nominal

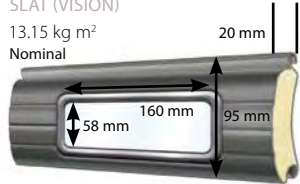

#### STANDARD CURTAIN & BOTTOM SLAT FINISH: GALVANISED



**THIS PRODUCT CAN BE POWDER COATED**

Please note: that this product will be powder coated after it has been assembled.



**THIS PRODUCT CAN BE PLASTISOL COATED**



**THIS PRODUCT CAN BE LAMINATED**

## Insulated industrial door

This insulated industrial door has been tested and approved to LPS 1175 and is also a recognised Secured by Design product.

### LPCB Requirements:

- The product must be internally face fitted around the opening
- The head (axle/box/canopy) must be concealed behind the structure of the building
- Bullet lock must be fitted to the internal side (accessed from the inside of the building only)

### Thermal and Acoustic Insulation

Minimal thermal bridges and the use of fine-pored PU rigid foam infill ensure good thermal insulation whilst curtain and sealing technology used around the entire shutter reduce noise from both inside and outside.

- Heat transmission performance for the 95 mm insulated Lath: Centre = 1.1 W/m<sup>2</sup>K, Quirk = 3.2 W/m<sup>2</sup>K
- Max width up to 7000 mm
- Max height up to 7000 mm
- Max area 44 m<sup>2</sup>
- Your choice of motor, see **Page 13**
- Choice of 4 guide arrangement options
- Standard guide angle is 100 mm x 50 mm
- Vision option available: 160 mm x 58 mm Clear Perspex
- Vision Panel with a minimum of 170 mm space in between
- Wind class rating: Class 5

#### SLAT, BOTTOM SLAT AND GUIDES

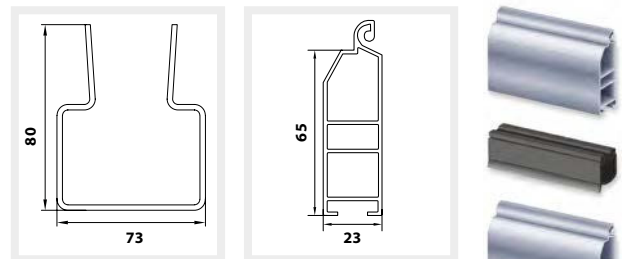

#### SLAT (INSULATED)

13.15 kg m<sup>2</sup>  
Nominal

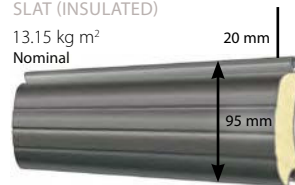

#### STANDARD CURTAIN & BOTTOM SLAT FINISH: GALVANISED



**THIS PRODUCT CAN BE POWDER COATED**

Please note: that this product will be powder coated after it has been assembled.



**THIS PRODUCT CAN BE LAMINATED**

#### Secured by Design



Police Preferred Specification



## Hardened steel insulated door

The twinwall steel makes this profile especially resistant to damage and reduces deflection.

### Thermal and Acoustic Insulation

Minimal thermal bridges and the use of CFC free insulation infill ensure good thermal insulation whilst curtain and sealing technology used around the entire shutter reduce noise from both inside and outside.

- Heat transmission performance for the CDC free insulation infill is 0.553 W/m<sup>2</sup>K
- Max width 7000 mm
- Max height 7000 mm
- Max area 49 m<sup>2</sup>
- Your choice of motor, see **Page 13**
- Can be powder coated any colour\*, see **Page 15**  
*\*the maximum width for powder coating is 6500 mm*
- Choice of 4 guide arrangement options
- Standard guide angle is 100 mm x 50 mm
- Vision option available – 200 mm x 55 mm Clear Perspex Vision Panel with a minimum of 200 mm space in between
- Wind class rating: Class 2

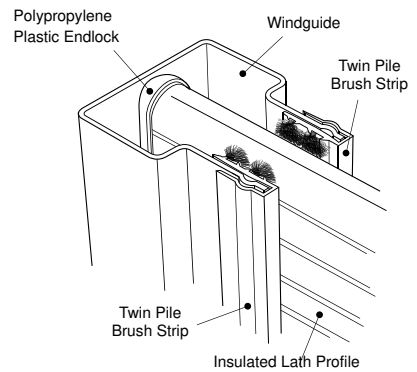
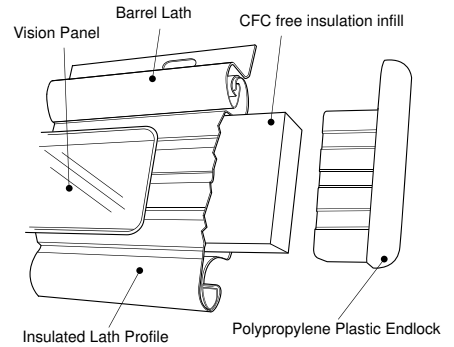

### GUIDE, SLAT AND BOTTOM SLAT

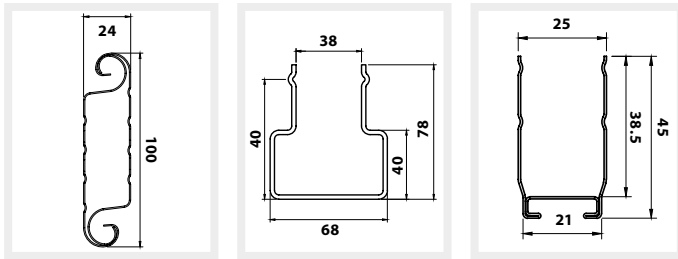

### THIS PRODUCT CAN BE POWDER COATED

- Please note:** that this product will be powder coated after it has been assembled.
- Please note:** this finish applies to the external face of the curtain slat only.
- Please note:** the maximum width for powder coating is 6500 mm.

### MOTOR OPTIONS

Comes with a GfA motor as standard. See **Page 13** for further options.

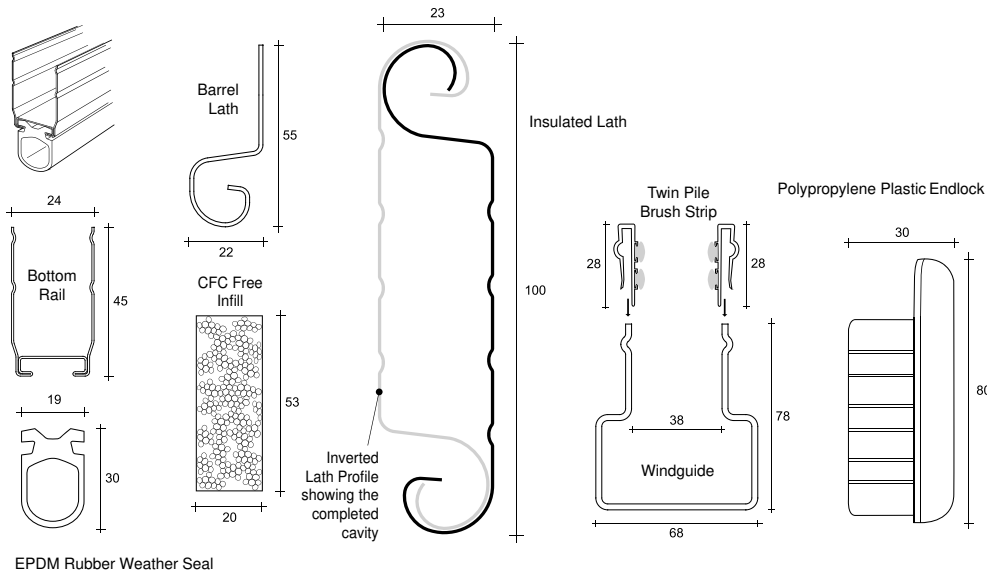

EPDM Rubber Weather Seal

## Industrial door

Our manual chain operated shutter combines all the qualities of our robust SeceuroDoor 75 but with the added benefit of manual operation.

- Max width 5000 mm
- Max height 5000 mm
- Max area 25 m<sup>2</sup>
- Can be powder coated any colour, see **Page 15**
- Choice of 4 guide arrangement options
- Standard guide angle is 75 mm x 50 mm  
Other sizes are available on request
- Vision option available, see **Page 8**
- Wind class rating: Class 2 (when used on 65 mm+ guides)

### SLAT, BOTTOM RAIL AND GUIDE OPTIONS

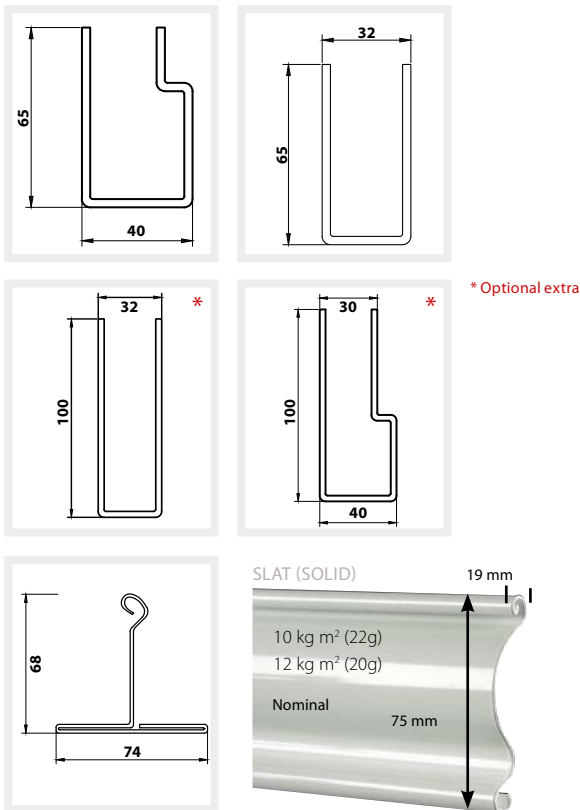

**THIS PRODUCT CAN BE POWDER COATED**

Please note: that this product will be powder coated after it has been assembled.



**THIS PRODUCT CAN BE PLASTISOL COATED**

Please note: this finish applies to the external face of the curtain slat only.

## Insulated industrial door

Our Insulated Commercial Shutter combines all the qualities of our robust SeceuroDoor 75 but with the added benefit of insulation.

### Thermal and Acoustic Insulation

Minimal thermal bridges and the use of fine-pored PU rigid foam infill ensure good thermal insulation whilst curtain and sealing technology used around the entire shutter reduce noise from both inside and outside.

- Heat transmission performance for an operational door unit 4.01 W/(m<sup>2</sup> K)
- Max width 5000 mm
- Max height 4000 mm
- Max area 20 m<sup>2</sup>
- Can be powder coated any colour, see **Page 15**
- Choice of 4 guide arrangement options
- Standard guide angle is 75 mm x 50 mm  
Other sizes are available on request

### SLAT, BOTTOM SLAT AND GUIDE

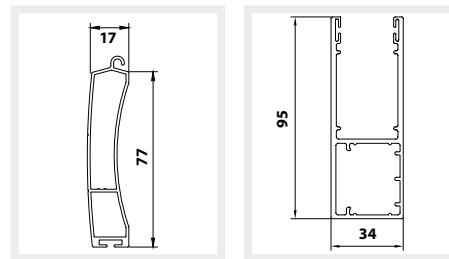

### SLAT (INSULATED)



### STANDARD CURTAIN & BOTTOM SLAT FINISH: GALVANISED



**THIS PRODUCT CAN BE POWDER COATED**

Please note: that this product will be powder coated after it has been assembled.

### STOCK COLOURS FOR CURTAIN (SLATS), BOTTOM SLAT, BOX & GUIDES



### BOX & GUIDES

Boxes and guides are supplied in White, Brilliant White, Black, Brown, or Cream at no extra charge.

### Please note:

Colour references on standard product are a guide only and will not match powder coated finish.

# SeceuroDoor Motor Options



Motor Spec			Motor Types		Power Supply		Usage
Motor	Torque (Nm)	RPM	Outboard (Direct Drive)	Inboard (Chain Drive)	Single Phase	Three Phase	Max Cycles per Hour
17/15	170	15	●			●	20
25/15	250	15	●			●	20
35/15	350	15	●			●	16
45/15	450	15	●			●	12
55/15	550	15	●			●	16
65/10	650	10	●			●	10
85/10	850	10	●			●	14
25/10W – Mini	250	10	●		●		8
45/07W	450	7	●		●		8
Ranger 90	90	32		●		●	16
Ranger 90W	70	32		●	●		12
Ranger 150	150	48		●		●	12

Safedrive® 35/15 to 65/10



Ranger 150

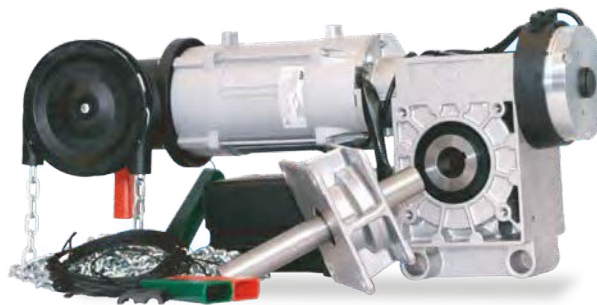

## Safedrive®

Drive Systems for non counter-balanced Industrial Doors

- Models from 170 Nm to 1800 Nm
- High precision worm drive gearbox
- Range of output speeds and torques
- Horizontal or vertical mounting
- Safety brake incorporated
- Low level hand chain operation as standard
- Plug-connected control equipment
- Certified to BS EN 12453

## Ranger 90 & 150

Drive Systems for Industrial Rolling Shutters

- Range of output speeds and torques
- Available with either digital or mechanical limits
- Horizontal or vertical mounting
- Low level hand chain operation as standard
- Plug-connected control equipment
- Certified to BS EN 12453:2001-02

**TIP**

Our online configurator automatically suggests drive options based on expected usage.



Link Controls

Ellard and Link motors are also available, price on application.

# Installation Options for SeceuroDoor Industrial Door

We are able to offer four standard variations of guide angle arrangement. The appropriate solution will depend on the structure the product is being fitted to and the application.

Drawings are available for each arrangement type.

	Arrangement	Guide angle inset or outset	Drawing reference
Motor	Face Fix	Inset/Outset	INDUS 001
	Reveal	Outset	INDUS 002
	Mixed	Inset/Outset	INDUS 003 & INDUS 004
Chain	Face	Inset/Outset	INDUS 005
	Reveal	Outset	INDUS 006

## Universal, Laser-cut, Folded End Plate (Motorised shown)

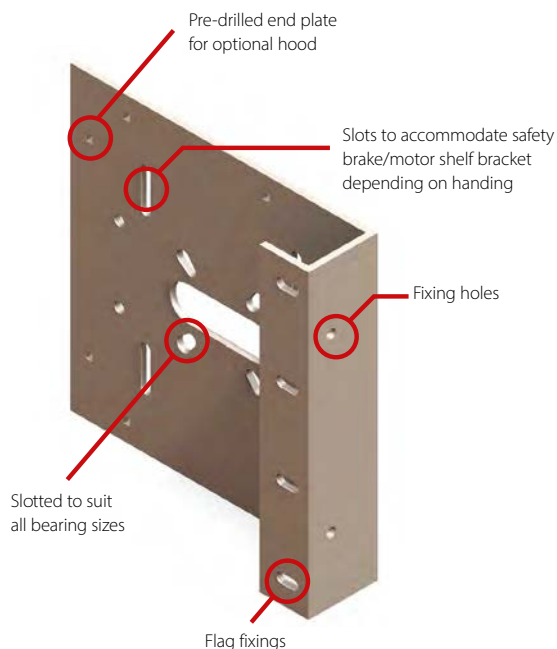

Typical Direct Drive Exploded Assembly



Typical Inboard Exploded Assembly

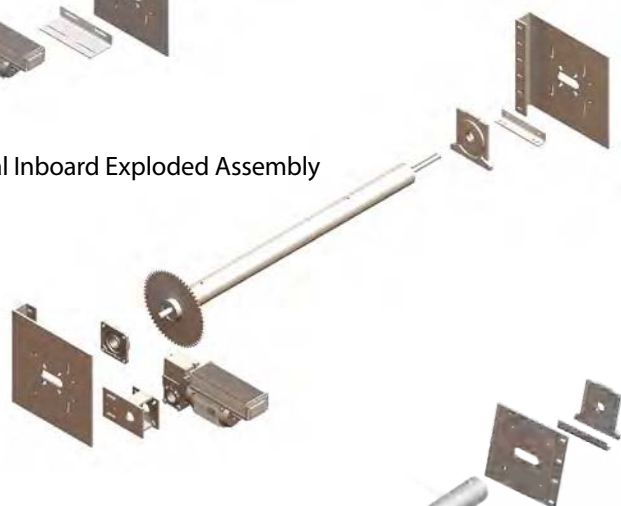

Typical Manual Chain Operated Exploded Assembly

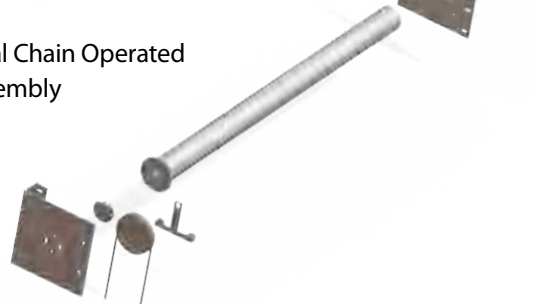

Exclusive 2 Year  
Extended Warranty



Available on GfA industrial motors

Only SWS UK offers an extended 2-year warranty on GfA industrial motors, when you register each drive using the GfA bluetooth dongle. Registration is easy and comes with a host of other benefits:

- ✓ View and track all your registered GfA assets in one place
- ✓ Monitor ongoing usage
- ✓ Keep track of drive settings over time
- ✓ Access a comprehensive library of fault codes
- ✓ Synch your service records

## Introduction

Polyester powder coating is a surface finish applied to shutters and retractable gates in a solid, powder form after careful pre-treatment of the surface. The coating is fused by heat to produce a continuous film and curing of the coating gives its design properties. The result is a high performance finish that delivers exceptional corrosion protection, durability and resistance to yellowing making it suitable for both interior and exterior use. The process is virtually emission free, so is environmentally friendly.

**Due to variations in our manufacturing process the guides and curtain may not be an exact match.**

## Features

- ✓ Typically 60-80 Microns coating thickness
- ✓ Excellent corrosion protection
- ✓ Superior colour stability
- ✓ Tough yet highly flexible

Extruded profiles and the aluminium shutter box profiles are powder coated in a satin finish (unless stated otherwise).

## Gloss levels

**Gloss (80% +/-5%):** A highly reflective smooth surface. Gloss surfaces due to their highly reflective appearance tend to highlight surface imperfections.

**Satin (65% +/-5%):** A satin finish is not as reflective as the gloss finish and because of this is less likely to show any surface imperfections. Satin finishes also provide a good surface for cleaning and resisting abrasion. Unless stated otherwise this is the standard finish supplied.

**Matt (30% +/-5%):** A matt finish due to the low gloss level is very good at concealing surface imperfections. Due to the textured finish the surface is more difficult to clean than a surface with a higher gloss level.

**Powder coating of the SeceuroDoor 100 will be to the external face only.**

**All colours are supplied in Satin as standard, Matt & Gloss are available.**

### Looking for something different?



If you require assistance identifying or selecting a colour which does not appear on our list of stock colours we can supply you with a RAL or BS colour chart.



























To see the full colour bands with the full range available visit [www.sws.co.uk/ral-colours/](http://www.sws.co.uk/ral-colours/)

**BAND A – For complete shutter (or curtain) using a colour listed in the band below.**

**\* FOC on SeceuroShield 75 box, guides and curtain**

## BAND B

## BAND C

✓ A name you can trust

When buying a SeceuroDoor product you can be reassured by the values behind the name. Every SeceuroDoor shutter is CE or UKCA marked and SWS UK is an ISO9001 and ISO14001 certified company.

✓ Expert advice

With a full-time technical team, field support and a 24 – hour helpline on hand you can be confident in choosing a product with first class backup and service.

✓ Manufactured in the UK

Using the latest machinery and equipment, all SeceuroDoor products are proudly manufactured and assembled in either our Lancaster or London factory.

✓ A solution for everyone

With so much choice SeceuroDoor products can accommodate most industrial door requirements, whether you need insulation, vision, or are looking for a solution for a specific budget.

✓ Engineered to perfection

Through continuous development and specialist engineering, SeceuroDoor products offer unrivalled quality and the most advanced specifications. High emphasis is placed on ease of fitting and flexibility on site.

## The importance of conformity and CE and UKCA marking

To comply with the Machinery Directive both the shutter and the motor and controller used in the installation must have a **Declaration of Performance** from the manufacturer.

On completion of the installation the installer must provide a **Declaration of Conformity** and apply a CE or UKCA mark giving details of the installations to the shutter / motor and controller combination, which is now classed as a machine.

The installer must issue to the customer a Declaration of Conformity, operating and maintenance instructions on the completion of the installation.

The installer must hold copies of both the Declaration of Performance and the Declaration of Conformity on a technical file for inspection by the relevant authorities.

If any of the above requirements are not fulfilled the installation is illegal.

Please ensure for your own safety and peace of mind that whoever installs your electric motor and controller is both willing and able to fulfil these requirements; if they are not – do not use them.

As a member of the DHF we CAN and WILL install your motor and controller safely and legally.

# Peace-of-Mind Warranties

All SeceuroDoor products, including the motor are guaranteed against defect of material or workmanship by SWS UK, subject to correct installation, maintenance and operation, for a period of 1 year from the date of purchase.

